

Summa

TABLES & DESKS

The Summa table series features excellent solutions for both individual work and teamwork. The strengths of these tables unquestionably lie in their versatile application, easy adaptability, durability and practicality. Thanks to their multi-functionality Summa is widely used in learning environments.

ISKU
Since 1928



Summa (rectangular)

DESKS AND LECTURE TABLES

Summa series include a wide variety of rectangular table top sizes to choose. The Summa table is suitable for individual work or lecture and group arrangements. The top's depth of 70 cm works particularly well in areas where tables are used to handle large drawings or materials.

Materials and finishing

Frame	Powder coated steel in ISKU standard colours
Table top	Wide variety of ISKU standard table top materials
Accessories	Backpack hooks, castors

Dimensions

Depth	600 / 700 mm
Width	800 / 1000 / 1200 / 1400 / 1600 mm (1800 available for the table with depth of 700 mm)
Height	640 / 710 / 730 / 830 mm

[More information on the table top chart.](#)



Summa

TABLES & DESKS | TABLE TOP CHART

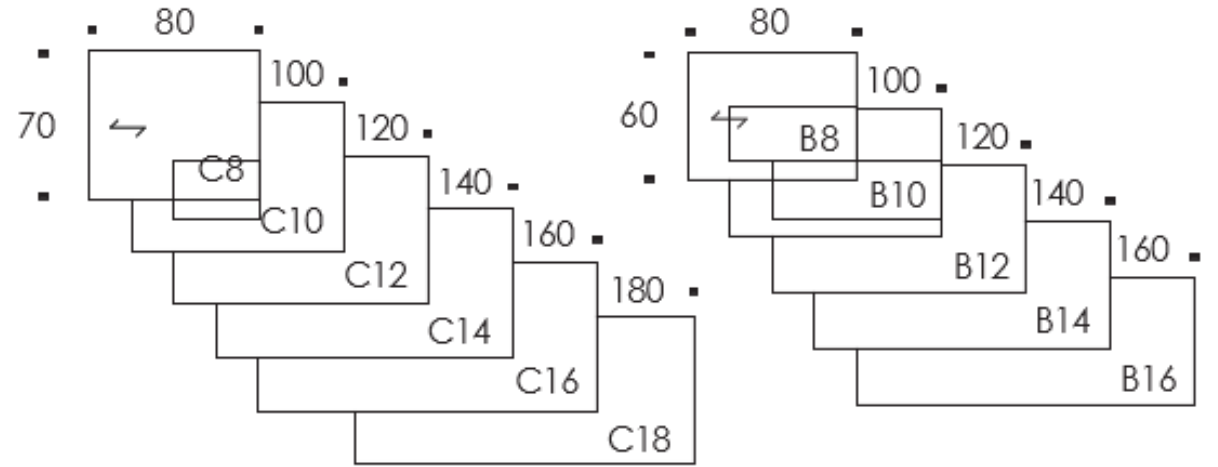
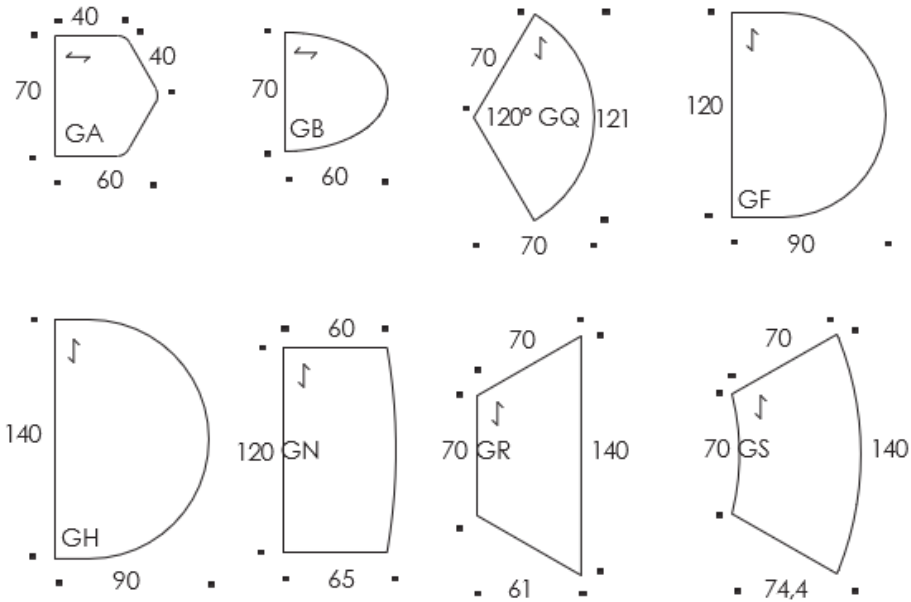

TOPS WITH TEAMIX CAST EDGE:



Available for Summa GA and 70x50 cm table tops.

TEAMIX CAST EDGE PROFILE:



Cast edge is molded into the table top's structure, which makes the edge seamless and tight.

Summa GA

DESKS AND LECTURE TABLES

The Summa GA classroom desk is an excellent fit for both individual and group work. Several different group work arrangements can be created with the GA desks. The legs of the desk can also be equipped with castors, which make it easy to move the desk.

A book basket placed under the top is available as a standard accessory. The front legs can be equipped with castors to make the tables easy to move.

Materials and finishing

Frame	Powder coated steel in ISKU standard colours
Table top	Wide variety of ISKU standard table top materials
Accessories	Backpack hooks, book basket, castors

Dimensions

Width	700 mm
Depth	600 mm
Height	640 / 710 / 730 / 830 mm

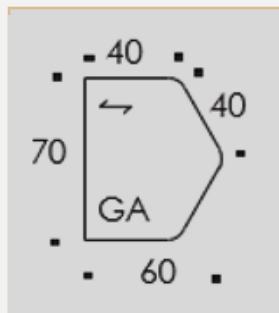



Summa GA

ISKU
Since 1928



Summa GA

ISKU
Since 1928



Summa GA

ISKU
Since 1928



Summa GA

ISKU
Since 1928

Summa GB

DESKS AND LECTURE TABLES

The Summa GB classroom desk is an excellent fit for both individual and group work. Several different group work arrangements can be created with the GB desks. The legs of the desk can also be equipped with castors, which make it easy to move the desk.

A book basket placed under the top is available as an accessory. The front legs can be equipped with castors to make the tables easy to move.

Materials and finishing

Frame Powder coated steel in ISKU standard colours

Table top Wide variety of ISKU standard table top materials

Accessories Backpack hooks, book basket, castors

Dimensions

Width 700 mm
Depth 600 mm
Height 640 / 710 / 730 / 830 mm

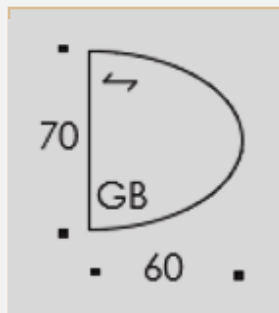



Summa GB

ISKU
Since 1928

Summa GF & GH

DESKS AND LECTURE TABLES

Summa GH and GF tables are a solution when you want a group work area with several group work stations. The tables can be placed either next to a wall or combined next to each other or arranged into small groups, which creates a meeting setting.

Materials and finishing

Frame	Powder coated steel in ISKU standard colours
Table top	Wide variety of ISKU standard table top materials
Accessories	Backpack hooks, castors

Dimensions

	GF	GH
Width	1200 mm	400 mm
Depth	900 mm	900 mm
Height	640 / 710 / 730 / 830 mm	

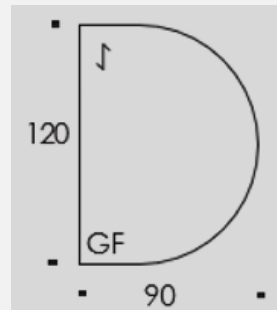



Summa GF

ISKU
Since 1928

Summa GR

DESKS AND LECTURE TABLES

The Summa GR table uses space efficiently, thanks to its shape and size. The GR table is particularly well suited for group work areas where the tables can be combined into different kinds of group work stations. The shape of the top is one of the best features of the GR table. There is enough room to work on each side of the table.

Materials and finishing

Frame	Powder coated steel in ISKU standard colours
Table top	Wide variety of ISKU standard table top materials
Accessories	Backpack hooks, castors

Dimensions

Width	1400 / 700 mm, sides 700 mm
Depth	610 mm
Height	640 / 710 / 730 / 830 mm

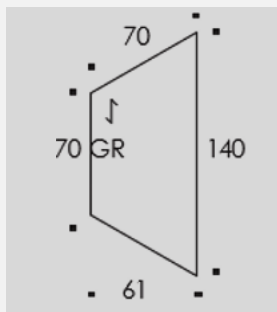



Summa GR

ISKU
Since 1928



Summa GR

ISKU
Since 1928

Summa GS

DESKS AND LECTURE TABLES

The Summa GS table is particularly well suited for group work areas where the tables can be combined into different kinds of group work stations. The shape of the top is one of the best features of the GR table. There is enough room to work on each side of the table.

Materials and finishing

Frame	Powder coated steel in ISKU standard colours
Table top	Wide variety of ISKU standard table top materials
Accessories	Backpack hooks, castors

Dimensions

Width	700 / 1400 mm, sides 700 mm
Depth	740,40 mm
Height	640 / 710 / 730 / 830 mm

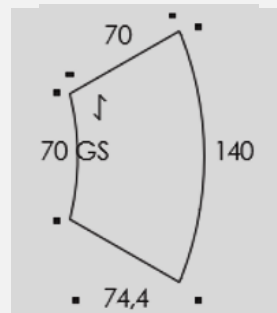



Summa GS

ISKU
Since 1928



Summa GS

ISKU
Since 1928

Summa

MATERIALS AND ACCESSORIES

LAMINATES

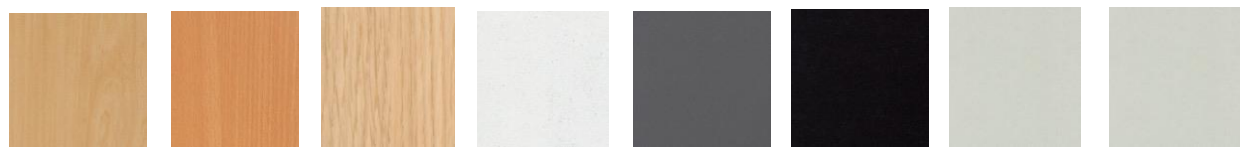

Lam 221/421
Birch

Lam 224
Beech

Lam 428
Oak

Lam 215/415
White

Lam 427
Dark Grey

Lam 435
Black

Lam 230/430
Light grey

Mel 130
Light grey

CAST EDGES



Birch 91

Beech 92

Green 93

Red 94

Grey 95

Blue 96

Black 29

White 28

METAL COLORS



IM-89
silver

IM-88
graphite

IM-72
black
(RAL 9005)

IM-73
white
(RAL 9016)

chrome

IM-84
Burgundy

IM-85
green

IM-86
blue

Raspberry
RAL 3012

Sky blue
RAL 6034

Sunny yellow
RAL 1018

Stone gray
RAL 7030

Forest green
RAL 6020

Taupe
RAL 7044

ACCESSORIES



Lockable
castor legs



GA cable basket