

PRODUCTS

Framery O

Ideal for one – awkward for two



Framery O is the perfect place for important calls or video conferences. World-class soundproofing mean you can have your discussions in privacy - without disturbing your colleagues. The classic office phone booth delivers leading sound insulation standards and echo-free acoustics, while automatic ventilation provides a comfortable working environment for one.

framery

Perfect for you

How do you work best? Design the pod to suit your needs.

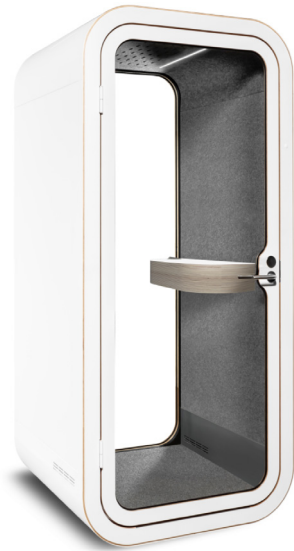

Framery O Quick Call

For quick calls

The Quick Call Package includes the basic features of a single-person pod that are needed for having a private phone call without disturbing your colleagues. In addition to superior sound insulation, it has a white high-pressure laminated table, acoustic interior felt, anti-static carpet, occupancy sensor, LED lighting and power outlet. Seat not included.



Framery O Standard

For heads down work

The Standard Package expands the use of a single-person pod to also include heads-down work. In addition to the core features of Framery O, it includes a fixed height-adjustable Tovi stool and power source with USB-C+A outlets.



Framery O Color

For unique look

The Color Package lets you select from all of the color options available for Framery O - making it an affordable way to fully personalize the pod. Select the color of the table, seat fabric, exterior covers, door and door frame.

Colors

Exterior

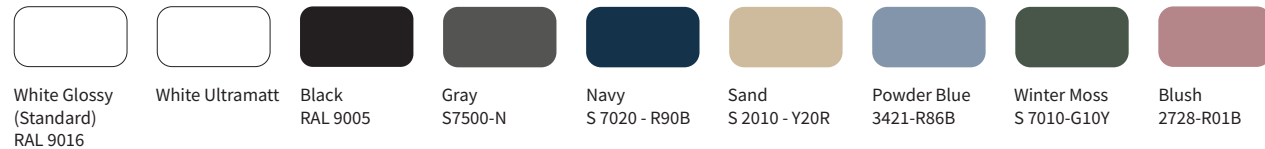

Frame

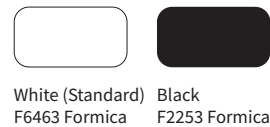

Table

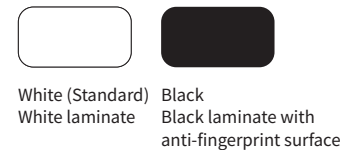

Seat fabrics

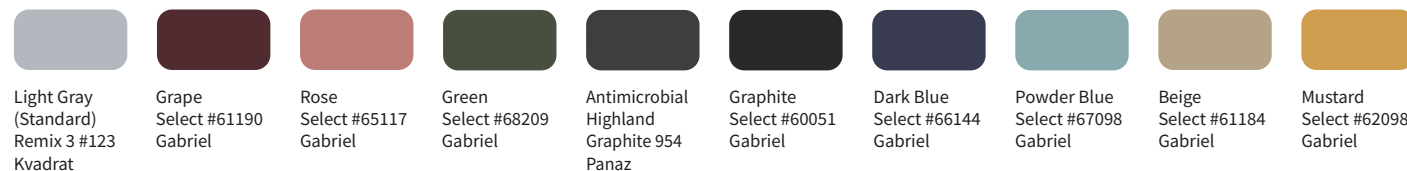

Technical Specifications

Size	221 cm x 100 cm x 100 cm (h, w, d) 87 in x 40 in x 40 in (h, w, d) With castors (comes with movability kit) extra 2 cm / 0.8 in in height
Weight	320 kg / 705 lb
Ventilation space	Minimum recommended space for air to circulate Sides: 5 cm / 1.9 in Above: 15 cm / 5.9 in
Acoustics	30 dB (Speech level reduction according to ISO-23351-1 testing method)
Airflow	Total airflow is 21,5 l/s, 45 CFM (77,4 m ³ /h) On standby mode the fans are working on 25 % of the maximum power.
Lighting	LED-Light: 4000 K and 300 lux
Exterior materials	Exterior Painted sheet metal or brushed stainless steel. Glass Sound control laminated glass. Frame Formica laminate on birch plywood with varnish trim.
Interior materials	Solid walls and roof: A sandwich element of sheet metal, birch plywood, recycled acoustic foam and acoustic felt. An anti-static and stain resistant low loop pile carpet for interior floor. Table Formica laminate on birch plywood with varnish trim.

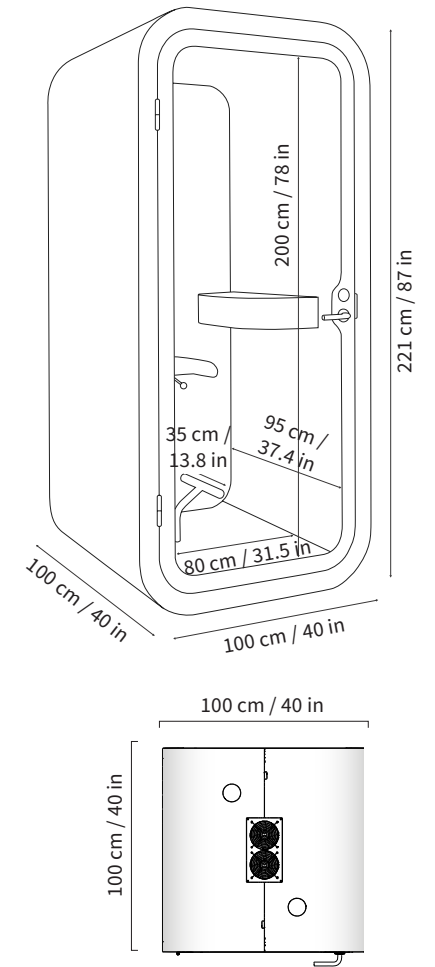

Power cord can be led out of the bottom corner of the pod.
The cord length outside the pods is 4,5 m / 176.4 in

Power

Power consumption

13 W while in use (Standard configuration)

- LED light: 10 W

- Fans in total: 3,1 W

0,8 W in standby mode

Input: 100-240 VAC, 8.0 A, 50-60 Hz

Regular table outlets

Power socket

Optional: LAN

Wide table outlets

Power socket, USB-A+C

Optional: LAN

Output values

Output VAC (power socket): 100-240 VAC, 6,6 A, 50-60 Hz

Output USB (TUF) charging:

Maximum combined output of 5 A at 5 VDC (25 W)

All electric components can be changed if there is a malfunction. Power consumption is a constant value that is determined by the power usage of the pods' internal components (electric unit, motion detector, light and fans). Framery's products can be plugged into a wall socket. The pods have their own power supplies that give 24 V DC to the lights and 12 V DC to the fans. The lights and fans are operated by a motion detector. Inside the pods, there are country-specific power outlets for charging mobile devices.

Certificates



Framery O, Q and 2Q are UL GREENGUARD certified



Framery O, Q, 2Q and One shipped in North America are UL 962 listed



Furniture



Excellent ergonomics

Put your laptop on the table, sit comfortably on the Tovi stool and do your thing. Height adjustability ensures that the stool accommodates all users. The stool is attached to the pod with a robust fixing plate making it stable and durable. The color of the seat can be customized.



Regular or wide table

Tables are designed to provide space for a laptop, a notebook and a mobile charging your devices while working or taking part in a call. There are two table options: regular and wide.

Regular table

13 cm × 70 cm × 28,5 cm (height, width, depth)
5.1 in × 27.5 in × 11.2 in (height, width, depth)
Table height from floor: 102,5 cm / 39.6 in



Wide table

12 cm × 75 cm × 30 cm (height, width, depth)
4.7 in × 29.5 in × 11.8 in (height, width, depth)
Table height from floor: 102,5 cm / 39.6 in

Functionalities

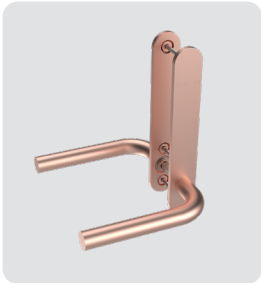

Copper-plated door handle

Copper has been used for health purposes since ancient times. According to a study by Centers for Disease Control and Prevention (CDC), viruses disintegrate quicker after landing on copper surfaces than on plastic or stainless steel surfaces.



Wireless charger (for wide table)

Charge your phone fast and wire-free inside our pods! The charger itself is located underneath the table, with a sticker on top of the table indicating where to place your phone to get it charged.



Power options include outlets with or without two charging USB-C+A sockets and a LAN cable lead-through. Wireless charging is also available.



Mobility kit Relocating your Framery pod has never been this easy! Mobility kit for Framery O includes six castors to make it easier to move the pod.



Self-closing hinges (white or black) can be used to limit the opening of doors and to make sure that they are not blocking passageways.



Smart Lock Compatible is a kit of parts that allows selected smart locks and key locks to be installed in Framery O, Q and 2Q.



Electromechanical code lock handle can be used to limit access to a pod only for users with a number code.



LAN cable 7 m